



KEOFITT CLASSIC W25



KEOFITT CLASSIC W25 SAMPLING VALVE

The KEOFITT CLASSIC W25 Sampling Valve is the largest KEOFITT sampling valve. Designed for sampling of very high viscosity products in the range of 0-250,000 cP and particles less than 17 mm in diameter. Sampling of more viscous liquids is possible, only will it take longer (depending on process pressure).



This valve is used in a range of industries such as food, dairy, pharmaceutical and bio-tech for products such as:

- Peanut Butter
- Fruit Pulp
- Syrup
- Cellulose
- Fruit Mixed Products
- Cosmetics

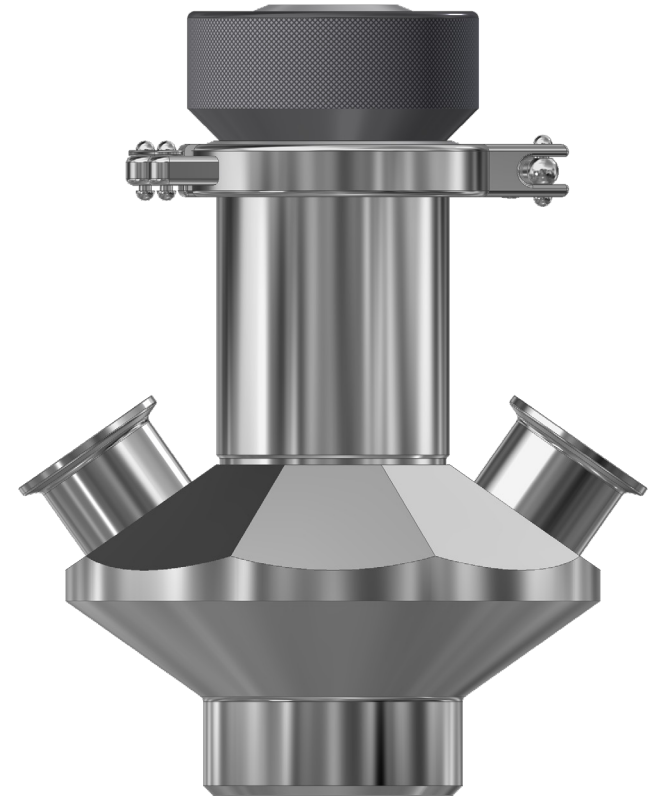
Available with PTFE membrane.



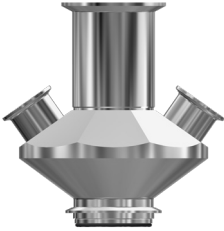





KEOFITT CLASSIC W25 VALVE - BODIES

	WELDING BODIES		CONNECTION BODIES	
	TANK WELDING	PIPE WELDING	VARIVENT Ø68	CLAMP 3"
W25 BODIES 1" CLAMP	 870001	<i>on request</i>	 870009	 870003
WELDING LINER	<i>on request</i>	<i>on request</i>	<i>on request</i>	<i>on request</i>

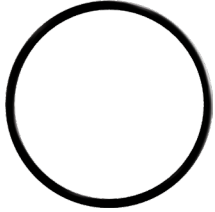
KEOFITT CLASSIC W25 VALVE - HEADS

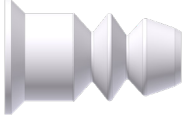
	TYPE N PNEUMATIC 0-6 BAR	TYPE B NO SPRING 0-12 BAR
	W25 HEADS PTFE	 875544

KEOFITT CLASSIC W25 - PARTS & ACCESSORIES

W25 PARTS & ACCESSORIES	O-RINGS	 <p>400208 EPDM 60X3</p>	 <p>900091 GASKET EPDM 1"</p>	 <p>900093 GASKET EPDM 3"</p>		
	MEMBRANES	 <p>870055 PTFE</p>				
	FOR VALVE HEADS	 <p>870255 TOOL PTFE</p>				
	MISC.	 <p>800014 ADAPTER TC/1"</p>	 <p>900086 CLAMP RING 1"</p>	 <p>900187 CLAMP RING FOR W25 VALVE</p>		