



# KEOFITT CLASSIC INGOLD



# KEOFITT CLASSIC INGOLD SAMPLING VALVE

The KEOFITT CLASSIC INGOLD sampling valve is designed to fit bio-connectors type Ingold®. Designed for the sampling of medium viscosity products in the range of 0-1000 cP with particles less than 2 mm in diameter, it covers most needs for liquid sampling. Sampling of more viscous liquids is possible, only will it take longer (depending on process pressure).

This valve is used in a range of industries such as brewery, dairy, pharmaceutical and bio-tech for products such as:







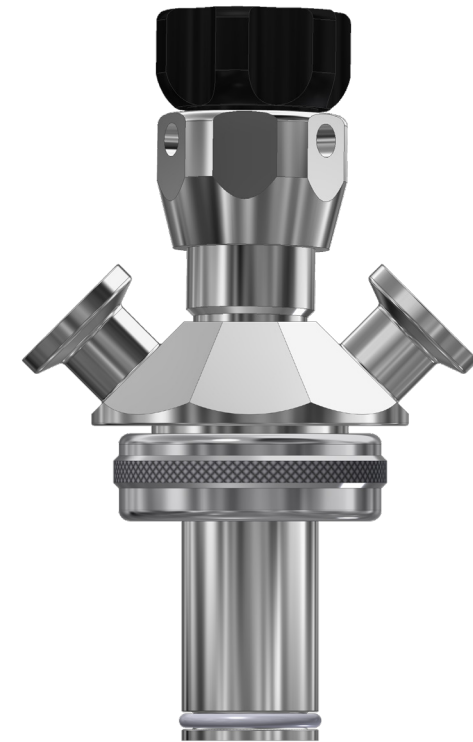















- Medical solutions
- Filtered Beer
- Creams and lotions
- Unprocessed milk

Besides the selection of the Valve Body and the Valve Head there are three different membrane materials to choose from: Silicone, EPDM and PTFE.

Accessories include quick couplings for the connection of tubing, piping and more.

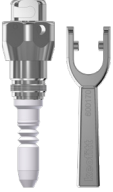





# KEOFITT CLASSIC INGOLD SAMPLING VALVE - BODIES & HEADS

|                      |                   | STANDARD FOR 40 MM PORT LENGTH*   |   | STANDARD FOR 52 MM PORT LENGTH*   |   |                   |         | TYPE H TURN KNOB 0-10 BAR(G)  |   | TYPE Q LEVER HANDLE 0-10 BAR(G)   |   | TYPE N LEVER HANDLE PNEUMATIC 0-10 BAR(G)   |   | TYPE N PNEUMATIC, ADJUSTABLE 0-10 BAR |
|----------------------|-------------------|---|---|---|---|-------------------|---------|---|---|---|---|---|---|---------------------------------------|
|                      |                   | HOSE PIECE  |   | MINI TRI-CLAMP  |   |                   |         | WELDING LINER   |   | SILICONE  |   | EPDM  |   | PTFE                                  |
| <b>INGOLD BODIES</b> |                   | <i>on request</i>   |   | <i>on request</i>   |   | <i>on request</i> |         |    |    |    |    |    |    | <i>on request</i>                     |
|                      |                   | <i>on request</i>   |   | <i>on request</i>   |   | <i>on request</i> |         | 310041  | 320041  | 310043  | 320043  | 310044  | 320044  |                                       |
|                      |                   |  |  |  |    | <i>on request</i> |         |    |    |    |    |    |    | <i>on request</i>                     |
|                      | <i>on request</i> | <i>on request</i>   | <i>on request</i>   | <i>on request</i>   |  | <i>on request</i> |         |  |  |  |  |  |  | <i>on request</i>                     |
|                      |                   |   |   |   |   |                   | 310041E | 320041E   | 310043E   | 320043E   | 310044E   | 320044E   |   |                                       |
|                      |                   |   |   |   |   |                   | 315541  | 325541  | 315543  | 325543  | 315544  | 325544  |   |                                       |

\* OTHER PORT LENGTH - AVAILABLE ON REQUEST

# KEOFITT CLASSIC INGOLD - PARTS & ACCESSORIES

| INGOLD - PARTS & ACCESSORIES | O-RINGS   | <br>300118<br>EPDM 20.24X2.62                 | <br>300119<br>20.24X2.62 FDA                 | <br>550184<br>FESTO                               |   |   |   |  |   |   |  |
|------------------------------|---|--|---|--|---|---|---|--|---|---|--|
| MEMBRANES                    | <br>310051<br>SILICONE (I40)           | <br>310052<br>EPDM (I40)                      | <br>310055<br>PTFE (I40)                     | <br>320051<br>SILICONE (I52)                      | <br>320052<br>EPDM (I52)                              | <br>320055<br>PTFE (I52)                               |   |  |   |   |  |
| FOR MINI TRI-CLAMP           | <br>300021<br>CLAMP PTFE 10/8          | <br>550004<br>PTFE TC 0.5M                    | <br>550005<br>PTFE TC 1.0M                   | <br>800014<br>ADAPTER MINI<br>CLAMP/1" CLAMP      | <br>800083<br>QC TC                                   | <br>900096<br>ADAPTER HP/TC                            | <br>900097<br>ADAPTOR M4<br>HP/TC        |  |   |   |  |
| VALVE HEADS                  | <br>300255<br>TOOL PTFE<br>(I40/I52)  | <br>550002.2<br>PTFE TUBING W/<br>QC/TC 0.5M | <br>550003.2<br>PTFE TUBING W/<br>QC/TC 1 M | <br>600149<br>BUSHING                            | <br>600170<br>LEVER HANDLE<br>Q/N                    | <br>600370<br>LEVER HANDLE<br>SELF-CLOSING            | <br>850840<br>PINOL SCREW F/<br>W9 HEAD | <br>900018<br>TOMMY BAR                    | <br>900074<br>GASKET EPDM<br>3/4" | <br>900087<br>GASKET EPDM<br>1/2" |  |
| MISC.                        | <br>320530<br>ADAPTOR 30MM<br>(I52)V | <br>320540<br>ADAPTOR 40 MM<br>(I52)        | <br>320830<br>ADAPTOR PTFE<br>50MM (I52)   | <br>400166<br>PROXIMITY<br>SWITCH FOR M4/<br>W9 | <br>600266<br>PROXIMITY<br>SENSOR W9<br>CLOSED POS. | <br>600267<br>PROXIMITY<br>SENSOR W9<br>MOUNTING KIT | <br>700108<br>HOSE PIECE W9            | <br>900021<br>BLIND CAP FOR<br>MINI CLAMP | <br>900075<br>CLAMP RING 1/2"    |   |  |

## HOW IT WORKS

